

AI Outdoor Parking Management Pro Bullet Plus Camera



DATASHEET



INTRODUCTION

Milesight AI Outdoor Parking Management Pro Bullet Plus Camera is designed for outdoor parking management. High-accuracy outdoor parking space detection based on AI algorithm enables simultaneous detection and management of up to 100 parking spaces. Besides, excellent scene adaptability realizes 24/7 parking management surveillance to help guide parking for more efficient and intelligent parking management. Make parking easy and smart!

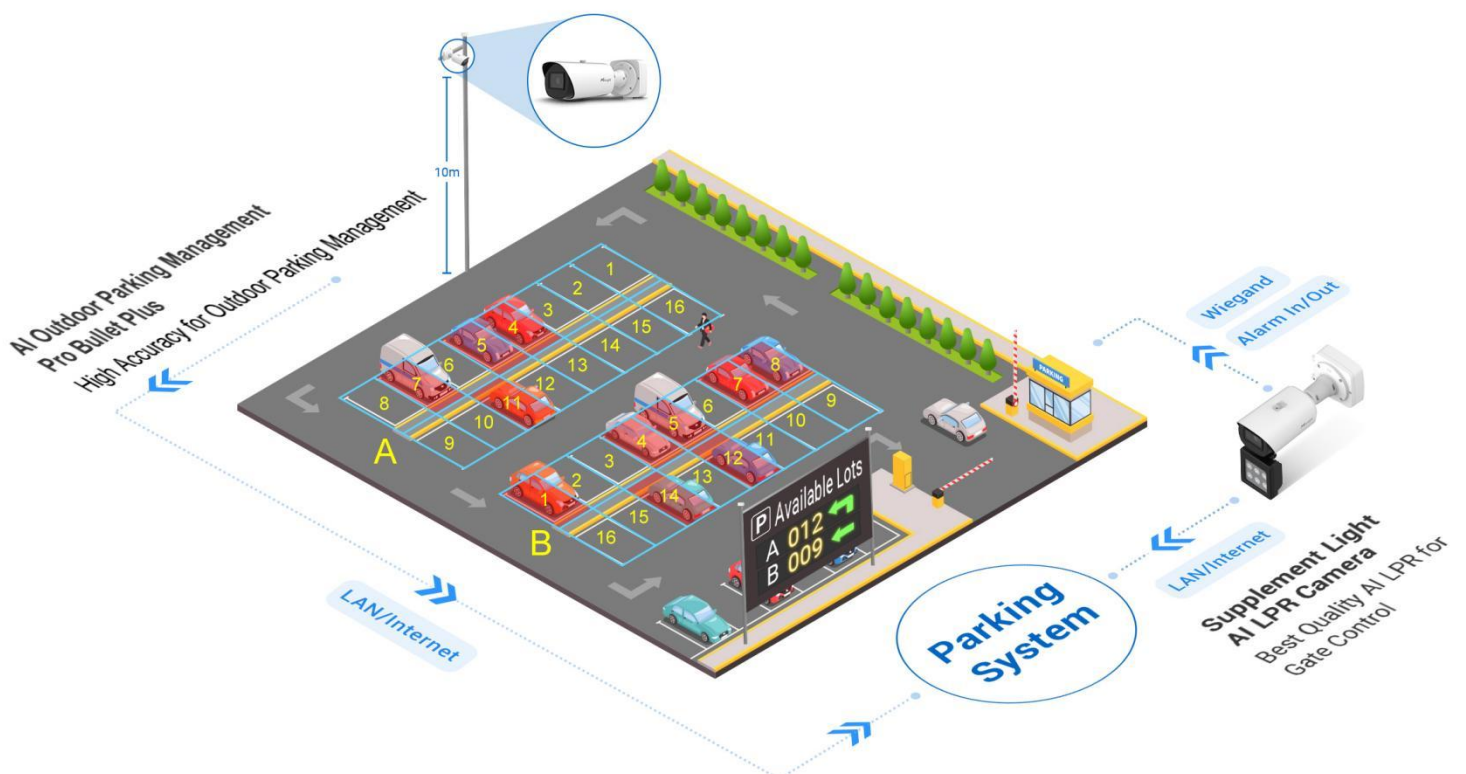



KEY FEATURES

Intelligent AI Parking Space Detection Algorithm

High-accuracy outdoor parking space detection based on AI algorithm can realize simultaneous detection and management of up to 100 parking spaces with up to 98% detection accuracy, which greatly helps guide parking and realizes more efficient and intelligent parking management.



Intelligence AI Algorithm

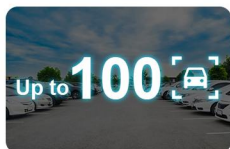

Up to 100 Parking Spaces Management



High Accuracy



Excellent Scene Adaptability

With a series of cutting-edge image technologies, AI Outdoor Parking Management has excellent scene adaptability. The wide field of view of the motorized zoom lens allows for a wider monitoring range, while the 4K resolution ensures that the images are sharp enough. In addition, under the 1/1.8" STARVIS starlight sensor and image-based frame accumulation technology, it also ensures the detection of parking lots at night, providing 24/7 surveillance monitoring.

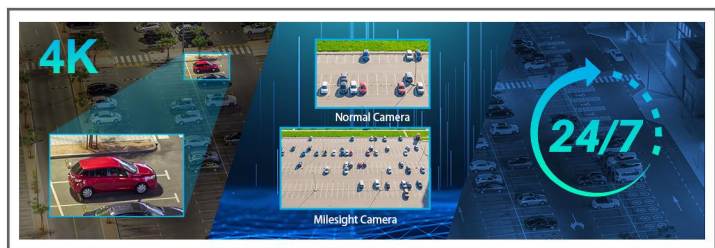

High compatibility

To maximize the usability and compatibility, the AI Outdoor Parking Management Camera supports CGI/APIs, which allows the easy open integration with third-party platforms. The network protocol such as HTTP(s) offers a wide range of options for data processing. The parking information is transmitted to the third-party parking system to help form a complete set of solutions, guide the driver to find the parking space quickly and realize intelligent management.



Unique Structure Design

The unique structure design of the camera enlarges the space and greatly saves efforts for installers, such as the integrated cable management bracket of Pro Bullet Plus Camera. And the IP67-rated weather proofing and IK10-rated vandal proofing allow to protect the camera against adverse impacts to ensure the robust performance.



Flexible Configuration

The configuration of Parking Space Detection is very flexible and convenient. Area Name, Planned Spaces of Area, Distribution and Numbering Scheme of the detection area can be customized, which provides a easy detection area configuration method and conforms to user habits. And the red overlay of the occupied parking space provides a more intuitive interface.



OBTAIN
THE USER MANUAL

AI Outdoor Parking Management Pro Bullet Plus Camera



	Name	PMC8266-FPC (4K)
Camera	Image Sensor	1/1.8" Progressive Scan CMOS
	Min. Illumination	Color: 0.009Lux@F1.4 B/W: 0Lux with IR on
	WDR	120dB Super WDR
	Shutter Time	1/100000s~1s
	IR Distance	Up to 65m
	Day/Night Mode	Day/Night/Auto/Customize/Schedule
	S/N	>55dB
Parking Space Management	Parking Space Detection	Up to 100 Parking Spaces@10m
	Detection Accuracy	>98%
	Data Report	Triggered Report: when parking space is occupied or released; Interval Report: regular report of entire parking situation
	Mounting Height	>3.5m
Lens	Lens	Motorized 3.6~10mm@F1.4
	Field of View	H116°~H48°/D134°~D55°/V65°~V27°
	Mount	Φ14
	Focus Control	Auto/Manual
Video	Max. Image Resolution	3840x2160
	Primary Stream	60Hz: 30fps@(3840x2160, 3072x2048, 2592x1944, 2592x1520, 2048x1536, 1920x1080, 1280x960, 1280x720, 704x576) 50Hz: 25fps@(3840x2160, 3072x2048, 2592x1944, 2592x1520, 2048x1536, 1920x1080, 1280x960, 1280x720, 704x576)
	Secondary Stream	60Hz: 30fps@(704x576, 640x480, 640x360, 352x288, 320x240, 320x192, 320x180) 50Hz: 25fps@(704x576, 640x480, 640x360, 352x288, 320x240, 320x192, 320x180)
	Tertiary Stream	60Hz: 30fps@(1920x1080, 1280x720, 704x576, 640x480, 640x360, 320x240, 320x192, 320x180) 50Hz: 25fps@(1920x1080, 1280x720, 704x576, 640x480, 640x360, 320x240, 320x192, 320x180)
	Video Compression	H.265*/H.265(HEVC)/H.264*/H.264/MJPEG
	Video Bit Rate	16Kbps~16Mbps(CBR/VBR Adjustable)
	Video	Privacy Masking
ROI		Up to 8 areas
Image Setting		Brightness/Contrast/Saturation/Sharpness

AI Outdoor Parking Management Pro Bullet Plus Camera



Interface	Ethernet	1*RJ45 10M/100M Ethernet Port
	Audio I/O	1/1
	Alarm I/O	1/1
Network	Network Storage	NAS(Support NFS, SMB/CIFS), ANR
	Protocol	IPv4/IPv6, ARP, TCP, UDP, RTCP, RTP, RTSP, RTMP, HTTP, HTTPS, DNS, DDNS, DHCP, FTP, NTP, SMTP, SNMP, UPnP, Bonjour, SIP, PPPoE, VLAN, 802.1x, QoS, IGMP, ICMP, SSL
Audio	Audio Compression	G.711/AAC/G.722/G.726
	Audio Sampling Rate	8/16/32/44.1/48KHz
	Audio Bit Rate	16~256kbps
	Two-way Audio	Support
System	Storage	microSD/SDHC/SDXC Card Local Storage, up to 256G
	Advanced Function	BLC, HLC, 2D DNR, 3D DNR, Defog, AWB, EIS, IP Address Filtering, AGC, Anti-flicker, Corridor Mode, Deblur, Watermark
	SIP/VoIP Support	Yes, Voice & Video-over-IP
	Event Trigger	Motion Detection, Network Disconnection, External Input, Audio Alarm, etc.
	Event Action	FTP Upload, SMTP Upload, SD Card Record, External Output, SIP Phone, HTTP Notification, etc.
	System Compatibility	ONVIF Profile G & Q & S & T, API
General	Working Temperature	-40℃~60℃
	Working Humidity	0~90%(Non-condensing)
	Power Supply	PoE (802.3af) / DC 12V±10%
	Power Consumption	8W MAX 17W MAX (With IR on)
	Housing	Vandal-proof IK10-rated Metal Housing / Up to IP67-rated for Weather-resistant Performance
	Surge Protection	4KV
	Weight	1630g
	Dimensions	301mmX108mmX126mm
	Warranty	3/5 Years

AI Outdoor Parking Management Pro Bullet Plus Camera



Structure Diagrams

microSD/SDHC/SDXC Card Slot

Reset

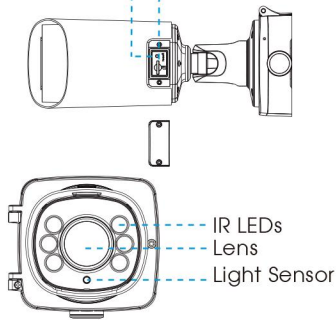

Ethernet Port (PoE)

Alarm/Audio

DC 12V

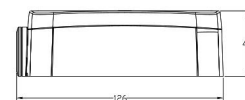
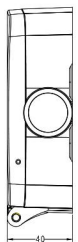
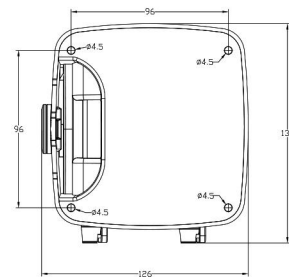
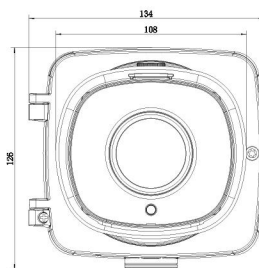
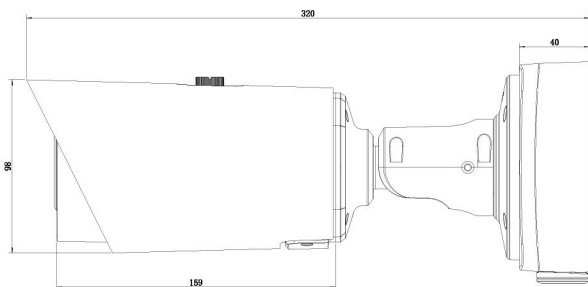
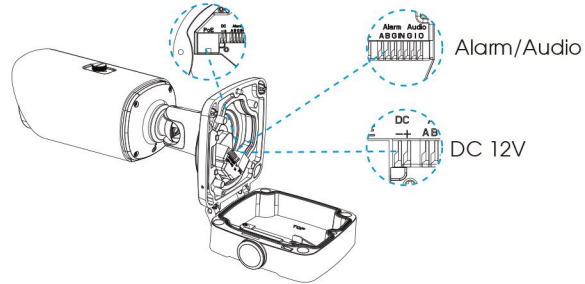

Units: mm

Accessories Support

A62 Junction Box(Default)

Weight: 510g
Dimensions: 134*126*40mm



A01 Pole Mount

Weight: 720g
Dimensions: 170*51.5*152.6mm



A03 External Corner Bracket

Weight: 900g
Dimensions: 170*152.5*76.3mm



Milesight Technology | www.milesight.com
Contact Us: sales@milesight.com support@milesight.com

Add: 220 NE 51st Street, Oakland Park, Florida 33334, USA
Tel: +1-800-561-0485

Add: 925, Anyang SK V1 Center, LS-ro 116beon-gil, Dongan-gu, Anvang-si, Korea
Tel: +82-31-990-7732

Add: Building C09, Software Park Phase III, Xiamen 361024, Fujian, China
Tel: +86-592-5922772

